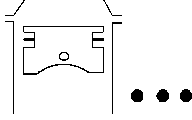
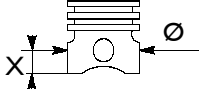
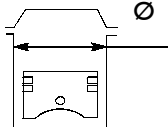
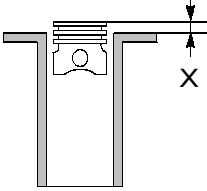
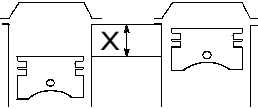
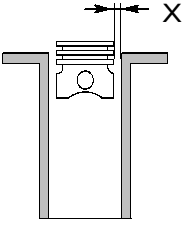
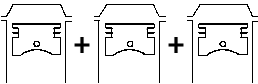
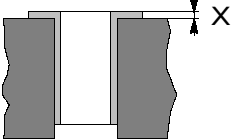
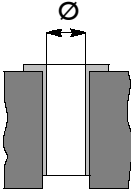
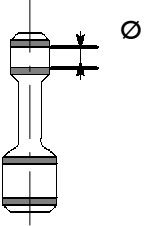
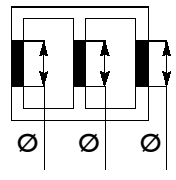
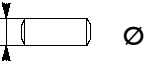
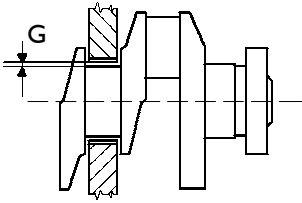
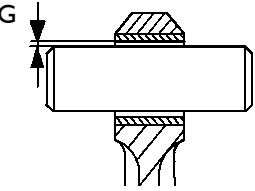
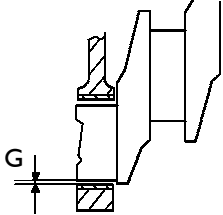
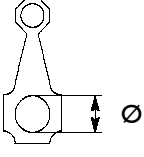
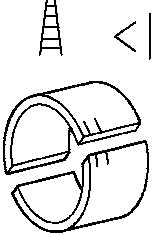
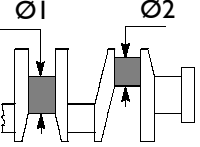
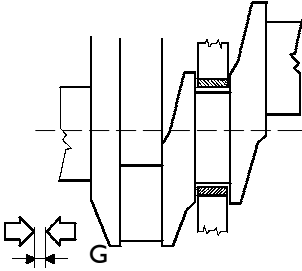
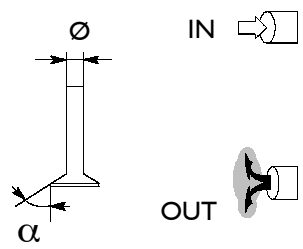
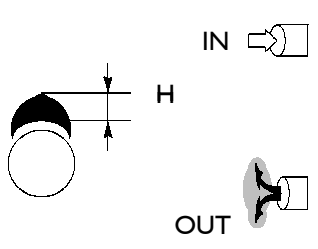
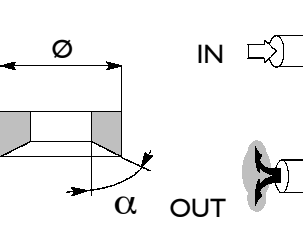
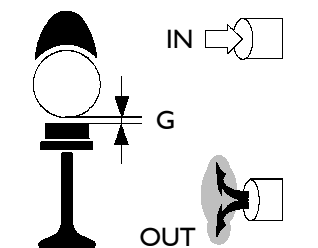
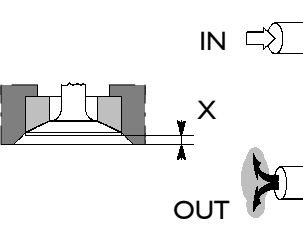
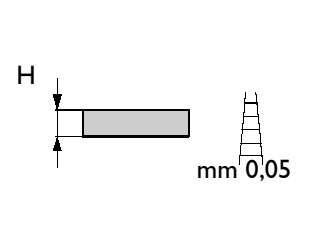
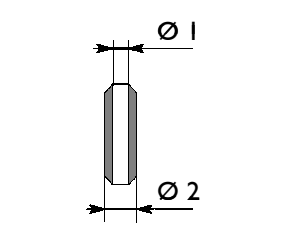
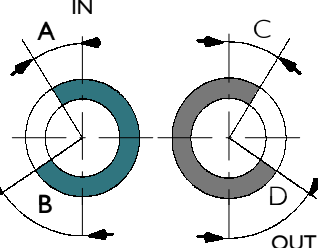
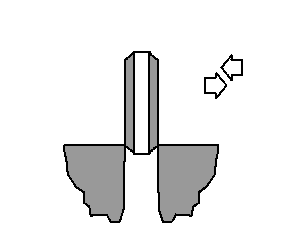
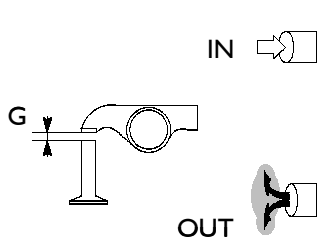

<p><b>1</b></p> 	Q.ty	6	<p><b>6</b></p> 	X mm	12
<p><b>2</b></p> 	Ø mm	104	<p><b>7</b></p> 	X mm	0,46 ÷ 0,79
<p><b>3</b></p> 	X mm	115	<p><b>8</b></p> 	X mm	0,130 ÷ 0,172
<p><b>4</b></p> 	cm <sup>3</sup>	586l	<p><b>9</b></p> 	X mm	—
<p><b>5</b></p> <p>Ø</p>		17 : 1	<p><b>10</b></p> 	Ø mm	104,000 ÷ 104,024

<p><b>11</b></p> 	<p>Ø 1 mm</p>	<p>38,004 ÷ 38,014</p>	<p><b>16</b></p> 	<p>Ø 1 mm</p>	<p>84,200 ÷ 84,230</p>
<p><b>12</b></p> 	<p>Ø 1 mm</p>	<p>37,983 ÷ 37,990</p>	<p><b>17</b></p> 	<p>G mm</p>	<p>0,034 ÷ 0,101</p>
<p><b>13</b></p> 	<p>G mm</p>	<p>0,014 ÷ 0,031</p>	<p><b>18</b></p> 	<p>G mm</p>	<p>0,033 ÷ 0,087</p>
<p><b>14</b></p> 	<p>Ø mm</p>	<p>67,407 ÷ 67,422</p>	<p><b>19</b></p> 	<p>mm</p>	<p>– 0,254 – 0,508 – 0,762 – 1,016</p>
<p><b>15</b></p> 	<p>Ø 1 mm</p>	<p>79,791 ÷ 79,810</p>	<p><b>20</b></p> 	<p>G mm</p>	<p>0,082 ÷ 0,334</p>
<p></p>	<p>Ø 2 mm</p>	<p>63,725 ÷ 63,744</p>	<p></p>	<p></p>	<p></p>

<p><b>21</b></p>	<p>X mm</p> <p>3,378 ÷ 3,429</p>	<p><b>26</b></p>	<p>I.P.</p> <p>PES 6A 90D</p>																								
<p><b>22</b></p>	<table border="1"> <tr> <td>mm</td> <td>Ø1</td> <td>55,280 ÷ 55,305</td> </tr> <tr> <td>mm</td> <td>Ø2</td> <td>54,780 ÷ 54,805</td> </tr> <tr> <td>mm</td> <td>Ø3</td> <td>54,280 ÷ 54,305</td> </tr> <tr> <td>mm</td> <td>Ø4</td> <td>53,780 ÷ 53,805</td> </tr> </table>	mm	Ø1	55,280 ÷ 55,305	mm	Ø2	54,780 ÷ 54,805	mm	Ø3	54,280 ÷ 54,305	mm	Ø4	53,780 ÷ 53,805	<p><b>27</b></p> <p>OIL PRESSURE</p>	<p>REG.</p> <p>MECHANICAL — RSV —</p> <p>bar</p> <p>MIN: 0,7</p> <p>MAX: 3</p>												
mm	Ø1	55,280 ÷ 55,305																									
mm	Ø2	54,780 ÷ 54,805																									
mm	Ø3	54,280 ÷ 54,305																									
mm	Ø4	53,780 ÷ 53,805																									
<p><b>23</b></p>	<table border="1"> <tr> <td>mm</td> <td>Ø1</td> <td>55,375 ÷ 55,430</td> </tr> <tr> <td>mm</td> <td>Ø2</td> <td>54,875 ÷ 54,930</td> </tr> <tr> <td>mm</td> <td>Ø3</td> <td>54,375 ÷ 54,430</td> </tr> <tr> <td>mm</td> <td>Ø4</td> <td>53,875 ÷ 53,930</td> </tr> <tr> <td>mm</td> <td>Ø1</td> <td>51,580 ÷ 51,630</td> </tr> <tr> <td>mm</td> <td>Ø2</td> <td>51,080 ÷ 51,130</td> </tr> <tr> <td>mm</td> <td>Ø3</td> <td>50,580 ÷ 50,630</td> </tr> <tr> <td>mm</td> <td>Ø4</td> <td>50,080 ÷ 50,130</td> </tr> </table>	mm	Ø1	55,375 ÷ 55,430	mm	Ø2	54,875 ÷ 54,930	mm	Ø3	54,375 ÷ 54,430	mm	Ø4	53,875 ÷ 53,930	mm	Ø1	51,580 ÷ 51,630	mm	Ø2	51,080 ÷ 51,130	mm	Ø3	50,580 ÷ 50,630	mm	Ø4	50,080 ÷ 50,130	<p><b>28</b></p>	<p>TYPE</p> <p>HOLSET "H2A"</p>
mm	Ø1	55,375 ÷ 55,430																									
mm	Ø2	54,875 ÷ 54,930																									
mm	Ø3	54,375 ÷ 54,430																									
mm	Ø4	53,875 ÷ 53,930																									
mm	Ø1	51,580 ÷ 51,630																									
mm	Ø2	51,080 ÷ 51,130																									
mm	Ø3	50,580 ÷ 50,630																									
mm	Ø4	50,080 ÷ 50,130																									
<p><b>24</b></p>	<table border="1"> <tr> <td>mm</td> <td>Ø1</td> <td>51,470 ÷ 51,500</td> </tr> <tr> <td>mm</td> <td>Ø2</td> <td>50,970 ÷ 51,000</td> </tr> <tr> <td>mm</td> <td>Ø3</td> <td>50,470 ÷ 50,500</td> </tr> <tr> <td>mm</td> <td>Ø4</td> <td>49,970 ÷ 50,000</td> </tr> </table>	mm	Ø1	51,470 ÷ 51,500	mm	Ø2	50,970 ÷ 51,000	mm	Ø3	50,470 ÷ 50,500	mm	Ø4	49,970 ÷ 50,000	<p><b>29</b></p>	<p>G mm</p> <p>0,30</p> <p>G mm</p> <p>0,30</p>												
mm	Ø1	51,470 ÷ 51,500																									
mm	Ø2	50,970 ÷ 51,000																									
mm	Ø3	50,470 ÷ 50,500																									
mm	Ø4	49,970 ÷ 50,000																									
<p><b>25</b></p>	<p>ORDER</p> <p>1 - 5 - 3 - 6 - 2 - 4</p>	<p><b>30</b></p>	<p>A</p> <p>79°</p> <p>B</p> <p>94°</p>																								

<p><b>31</b></p> 	<p><math>\alpha</math> <math>\varnothing</math> mm</p>	<p><math>60^{\circ} 30' \pm 7'</math> <math>7,985 \div 8,000</math></p>	<p><b>36</b></p> 	<p>H mm</p>	<p>5,9715</p>
<p><b>32</b></p> 	<p><math>\alpha</math> <math>\varnothing</math> mm</p>	<p><math>60^{\circ} \pm 5'</math> —</p>	<p><b>37</b></p> 	<p>G mm</p>	<p>—</p>
<p><b>33</b></p> 	<p>X mm</p>	<p><math>0,7 \div 1,0</math></p>	<p><b>38</b></p> 	<p>H mm</p>	<p>—</p>
<p><b>34</b></p> 	<p><math>\varnothing 1</math> mm</p>	<p><math>8,023 \div 8,043</math></p>	<p><b>39</b></p> 	<p>A B C D</p>	<p><math>4^{\circ} 30'</math> <math>46^{\circ}</math> <math>48^{\circ} 30'</math> <math>6^{\circ}</math></p>
<p><b>35</b></p> 	<p>mm</p>	<p><math>0,010 \div 0,066</math></p>	<p><b>40</b></p> 	<p>G mm</p>	<p>0,25 0,35</p>

<p><b>41</b></p>	<p>X mm</p>	<p>0,3 ÷ 1,1</p>	<p><b>46</b></p>	<p>Nm Nm <math>\alpha</math> <math>\alpha</math></p>	<p>1<sup>st</sup> STEP 60 2<sup>nd</sup> STEP 60 3<sup>rd</sup> STEP 90° 4<sup>th</sup> STEP 90°</p>
<p><b>42</b></p>	<p>X mm</p>	<p>2,2 ÷ 2,3</p>	<p><b>47</b></p>	<p>Nm <math>\alpha</math></p>	<p>1<sup>st</sup> STEP 40 2<sup>nd</sup> STEP 60°</p>
<p><b>43</b></p>	<p>bar</p>	<p>230 ± 8</p>	<p><b>48</b></p>	<p>Nm</p>	<p>320</p>
<p><b>44</b></p>	<p>bar</p>	<p>19</p>	<p><b>49</b></p>	<p>Nm <math>\alpha</math></p>	<p>1<sup>st</sup> STEP — 2<sup>nd</sup> STEP —</p>
<p><b>45</b></p>	<p>Nm <math>\alpha</math></p>	<p>— —</p>	<p><b>50</b></p>	<p>Nm <math>\alpha</math></p>	<p>1<sup>st</sup> STEP 80 2<sup>nd</sup> STEP 90°</p>

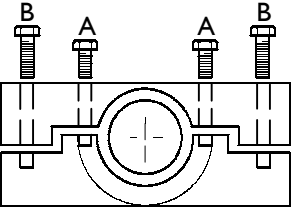
<p><b>51</b></p> 	Nm	1 <sup>st</sup> STEP —
	$\alpha$	2 <sup>nd</sup> STEP —

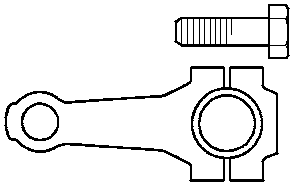
<p><b>52</b></p> 	Nm	1 <sup>st</sup> STEP 40
	$\alpha$	2 <sup>nd</sup> STEP 60°

**NOTES:**