

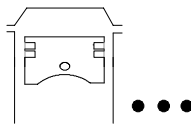

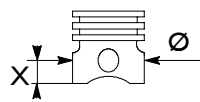
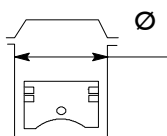
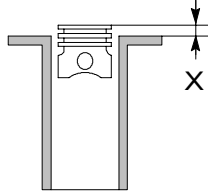
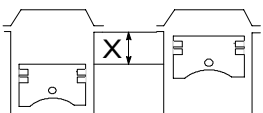
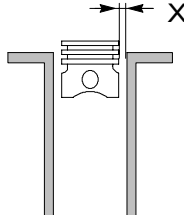
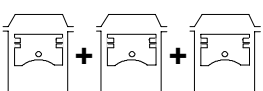
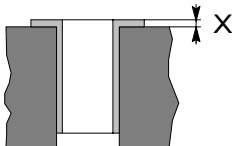
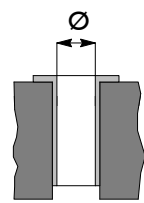
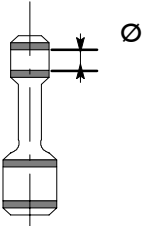
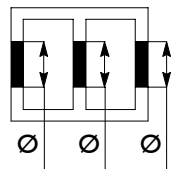
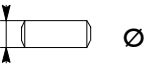
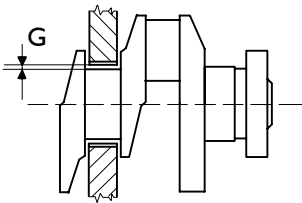
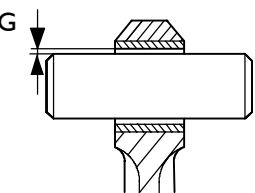
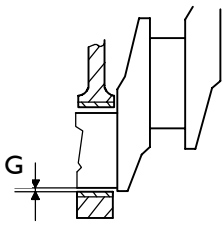
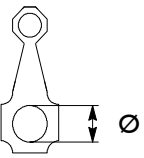
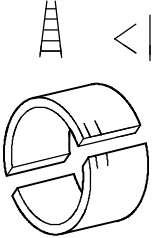
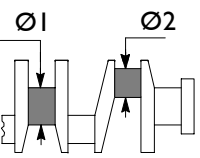
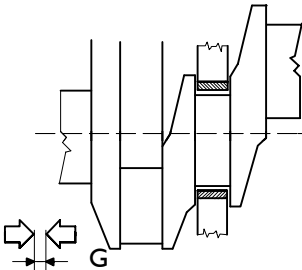
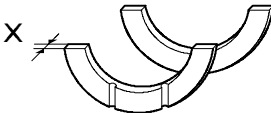
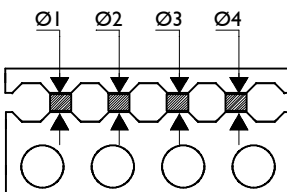
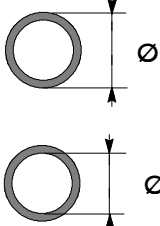
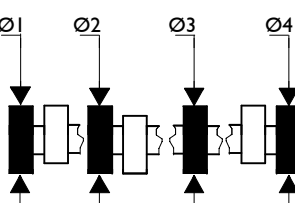
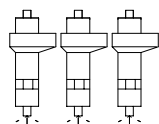
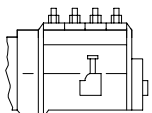

<p>1</p> 	<p>Q.ty</p>	<p>8</p>	<p>6</p> 	<p>X mm</p>	<p>21</p>
<p>2</p> 	<p>Ø mm</p>	<p>145</p>	<p>7</p> 	<p>X mm</p>	<p>0,45 ÷ 0,15</p>
<p>3</p> 	<p>X mm</p>	<p>130</p>	<p>8</p> 	<p>X mm</p>	<p>0,173 ÷ 0,217</p>
<p>4</p> 	<p>cm³</p>	<p>17174</p>	<p>9</p> 	<p>X mm</p>	<p>0,03 ÷ 0,09</p>
<p>5</p> <p>Ø</p>		<p>15,9 : 1</p>	<p>10</p> 	<p>Ø mm</p>	<p>145,000 ÷ 145,030</p>

<p>11</p> 	<p>Ø 1 mm</p>	<p>55,015 ÷ 55,030</p>	<p>16</p> 	<p>Ø 1 mm</p>	<p>118,000 ÷ 118,022</p>
<p>12</p> 	<p>Ø 1 mm</p>	<p>54,982 ÷ 54,990</p>	<p>17</p> 	<p>G mm</p>	<p>0,067 ÷ 0,127</p>
<p>13</p> 	<p>G mm</p>	<p>0,025 ÷ 0,048</p>	<p>18</p> 	<p>G mm</p>	<p>0,060 ÷ 0,120</p>
<p>14</p> 	<p>Ø mm</p>	<p>97,950 ÷ 97,972</p>	<p>19</p> 	<p>mm</p>	<p>-0,127 -0,254 -0,508 -0,762 -1,016</p>
<p>15</p> 	<p>Ø 1 mm</p>	<p>112,975 ÷ 112,995</p>	<p>20</p> 	<p>G mm</p>	<p>0,070 ÷ 0,270</p>
<p>Ø 2 mm</p>	<p>94,232 ÷ 94,252</p>				

<p>21</p> 	<p>X mm</p>	<p>3,378 ÷ 3,429</p>																				
<p>22</p> 	<p>mm</p>	<table border="1"> <tr> <td>Ø1</td> <td>76,480 ÷ 76,520</td> </tr> <tr> <td>Ø2</td> <td>76,980 ÷ 77,020</td> </tr> <tr> <td>Ø3</td> <td>77,480 ÷ 77,520</td> </tr> <tr> <td>Ø4</td> <td>77,980 ÷ 78,020</td> </tr> <tr> <td>Ø5</td> <td>78,480 ÷ 78,520</td> </tr> </table>	Ø1	76,480 ÷ 76,520	Ø2	76,980 ÷ 77,020	Ø3	77,480 ÷ 77,520	Ø4	77,980 ÷ 78,020	Ø5	78,480 ÷ 78,520										
Ø1	76,480 ÷ 76,520																					
Ø2	76,980 ÷ 77,020																					
Ø3	77,480 ÷ 77,520																					
Ø4	77,980 ÷ 78,020																					
Ø5	78,480 ÷ 78,520																					
<p>23</p> 	<p>mm</p>	<table border="1"> <tr> <td>Ø1</td> <td>76,590 ÷ 76,640</td> </tr> <tr> <td>Ø2</td> <td>77,090 ÷ 77,140</td> </tr> <tr> <td>Ø3</td> <td>77,590 ÷ 77,640</td> </tr> <tr> <td>Ø4</td> <td>78,090 ÷ 78,140</td> </tr> <tr> <td>Ø5</td> <td>78,590 ÷ 78,640</td> </tr> <tr> <td>Ø1</td> <td>70,570 ÷ 70,620</td> </tr> <tr> <td>Ø2</td> <td>71,070 ÷ 71,120</td> </tr> <tr> <td>Ø3</td> <td>71,570 ÷ 71,620</td> </tr> <tr> <td>Ø4</td> <td>72,070 ÷ 72,120</td> </tr> <tr> <td>Ø5</td> <td>72,170 ÷ 72,620</td> </tr> </table>	Ø1	76,590 ÷ 76,640	Ø2	77,090 ÷ 77,140	Ø3	77,590 ÷ 77,640	Ø4	78,090 ÷ 78,140	Ø5	78,590 ÷ 78,640	Ø1	70,570 ÷ 70,620	Ø2	71,070 ÷ 71,120	Ø3	71,570 ÷ 71,620	Ø4	72,070 ÷ 72,120	Ø5	72,170 ÷ 72,620
Ø1	76,590 ÷ 76,640																					
Ø2	77,090 ÷ 77,140																					
Ø3	77,590 ÷ 77,640																					
Ø4	78,090 ÷ 78,140																					
Ø5	78,590 ÷ 78,640																					
Ø1	70,570 ÷ 70,620																					
Ø2	71,070 ÷ 71,120																					
Ø3	71,570 ÷ 71,620																					
Ø4	72,070 ÷ 72,120																					
Ø5	72,170 ÷ 72,620																					
<p>24</p> 	<p>mm</p>	<table border="1"> <tr> <td>Ø1</td> <td>70,470 ÷ 70,500</td> </tr> <tr> <td>Ø2</td> <td>70,970 ÷ 71,000</td> </tr> <tr> <td>Ø3</td> <td>71,470 ÷ 71,500</td> </tr> <tr> <td>Ø4</td> <td>71,970 ÷ 72,000</td> </tr> <tr> <td>Ø5</td> <td>72,470 ÷ 72,500</td> </tr> </table>	Ø1	70,470 ÷ 70,500	Ø2	70,970 ÷ 71,000	Ø3	71,470 ÷ 71,500	Ø4	71,970 ÷ 72,000	Ø5	72,470 ÷ 72,500										
Ø1	70,470 ÷ 70,500																					
Ø2	70,970 ÷ 71,000																					
Ø3	71,470 ÷ 71,500																					
Ø4	71,970 ÷ 72,000																					
Ø5	72,470 ÷ 72,500																					
<p>25</p> 	<p>ORDER</p>	<p>1 - 3 - 7 - 2 - 6 - 5 - 4 - 8</p>																				

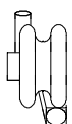
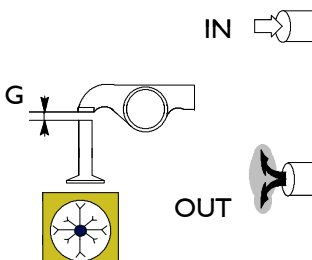
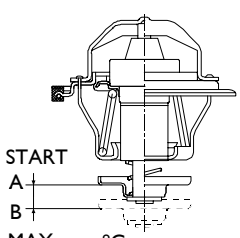
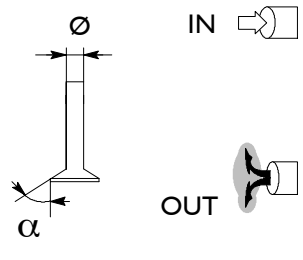
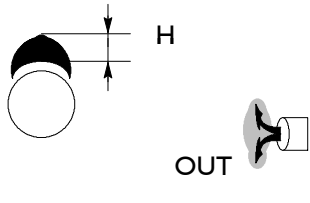
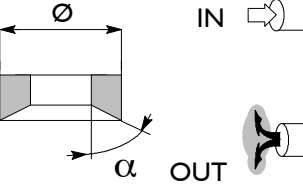
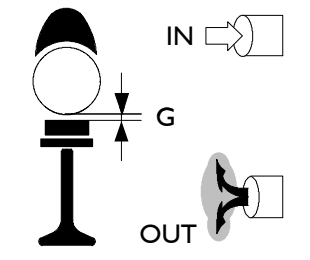
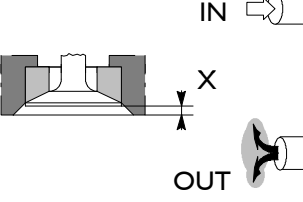
<p>26</p> 	<p>I.P.</p>	<p>BOSCH PE 8P 130A</p>
<p>27</p> <p>OIL PRESSURE</p> 	<p>REG.</p>	<p>MECHANICAL "RSV"</p>
<p>28</p> 	<p>TYPE</p>	<p>HOLSET "H2D" (Q.=2)</p>
<p>29</p> 	<p>G mm</p>	<p>0,20 + 0,05</p>
<p>30</p> 	<p>A</p>	<p>68°</p>
<p>START A B MAX °C</p>	<p>B</p>	<p>83°</p>

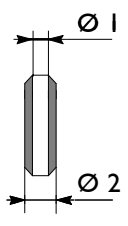
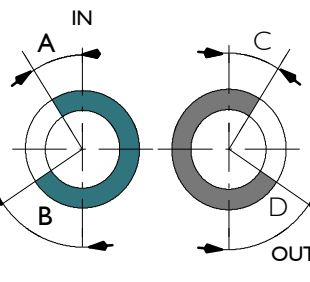
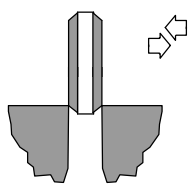
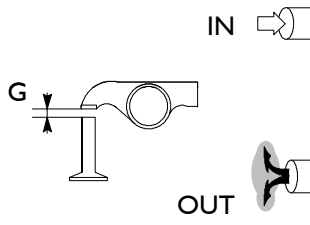
<p>31</p> 	<p>α</p> <p>\varnothing mm</p>	<p>$60^{\circ} 15' \pm 5'$</p> <p>$9,985 \div 10,000$</p>	<p>36</p> 	<p>H mm</p>	<p>7,55</p>
<p>32</p> 	<p>α</p> <p>\varnothing mm</p>	<p>$60^{\circ} 15'$</p> <p>$54,172 \div 54,202$</p>	<p>37</p> 	<p>G mm</p>	<p>—</p>
<p>33</p> 	<p>X mm</p>	<p>$+0,2 \div +0,5$</p>	<p>38</p> 	<p>H mm</p>	<p>—</p>
<p>34</p> 	<p>$\varnothing 1$ mm</p>	<p>$10,025 \div 10,040$</p>	<p>39</p> 	<p>A</p> <p>B</p>	<p>$8^{\circ} 42'$</p> <p>$43^{\circ} 6'$</p>
<p>35</p> 	<p>mm</p>	<p>$0,010 \div 0,039$</p>	<p>40</p> 	<p>G mm</p>	<p>0,30</p>
			<p>G mm</p>	<p>0,40</p>	

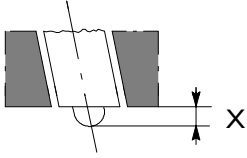
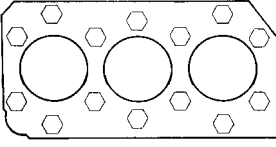
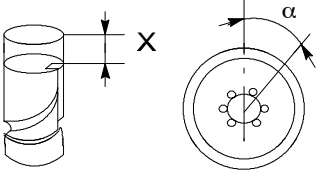
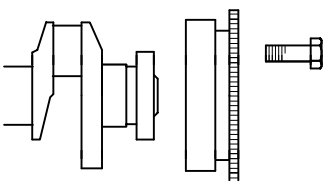
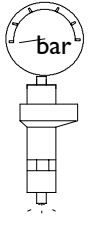
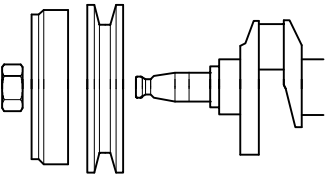
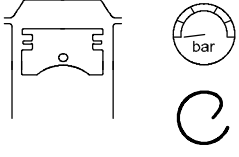
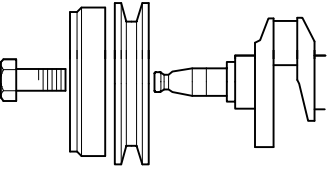
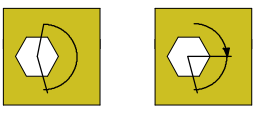
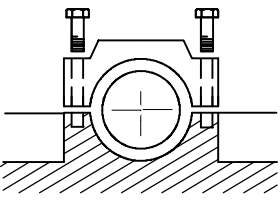
<p>41</p> 	<p>X mm</p>	<p>1,97 ÷ 2,74</p>	<p>46</p> 	<p>Nm Nm α</p>	<p>1st STEP 30 2nd STEP 160 3rd STEP 150°</p>
<p>42</p> 	<p>X mm</p>	<p>5,00 ÷ 5,10</p>	<p>47</p> 	<p>Nm α</p>	<p>1st STEP 140 2nd STEP 60°</p>
<p>43</p> 	<p>bar</p>	<p>250 + 8</p>	<p>48</p> 	<p>Nm</p>	<p>—</p>
<p>44</p> 	<p>bar</p>	<p>20</p>	<p>49</p> 	<p>Nm α</p>	<p>1st STEP 196 2nd STEP —</p>
<p>45</p> 	<p>Nm α</p>	<p>— —</p>	<p>50</p> 	<p>Nm α</p>	<p>1st STEP TOP 80 SIDE 60 2nd STEP TOP 120° SIDE 90°</p>

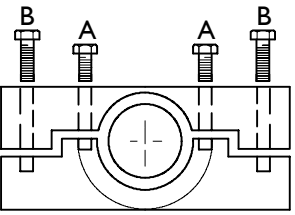
51		Nm	1 st STEP —
		α	2 nd STEP —

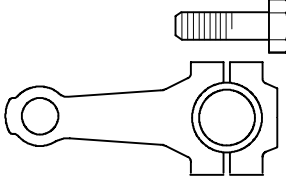
52		Nm	1 ^s STEP 100
		α	2 nd STEP 120°

NOTES: