

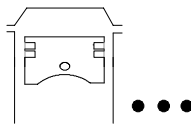
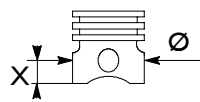
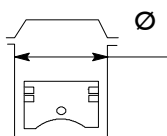
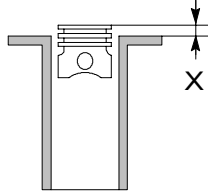
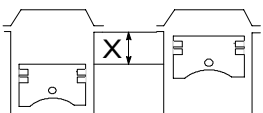
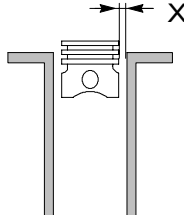
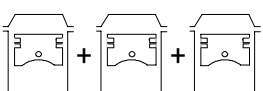
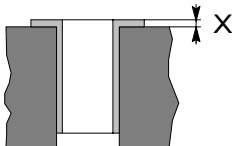
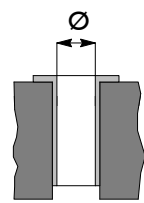
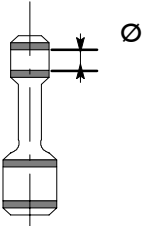
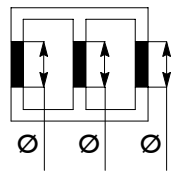
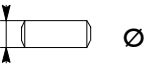
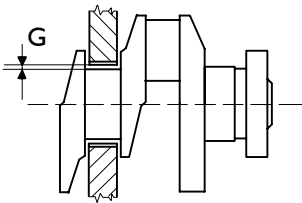
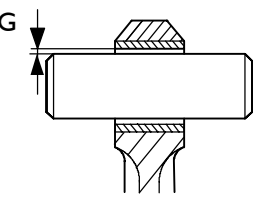
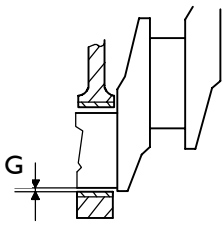
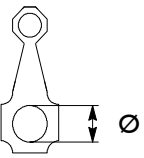
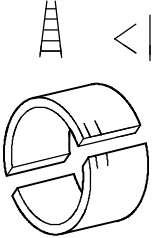
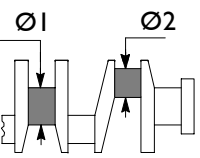
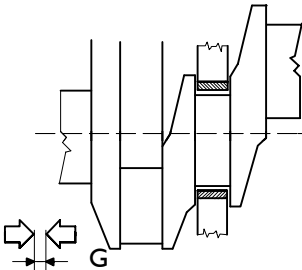
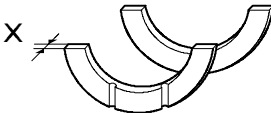
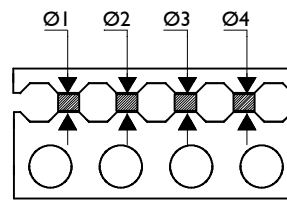
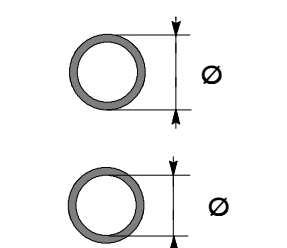
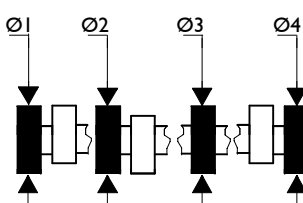
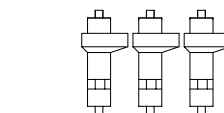
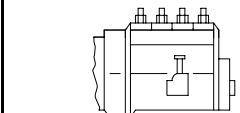
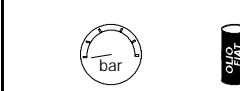
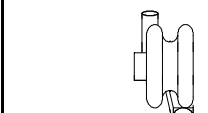
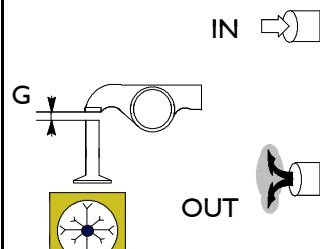
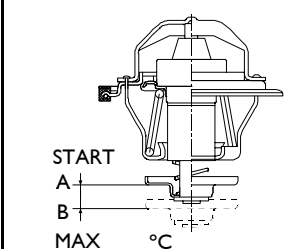
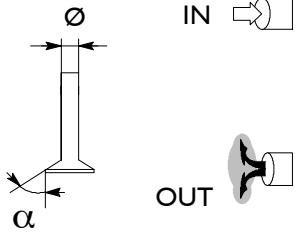
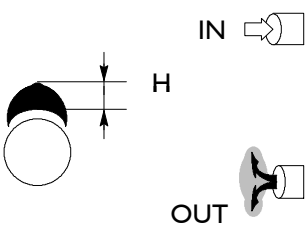
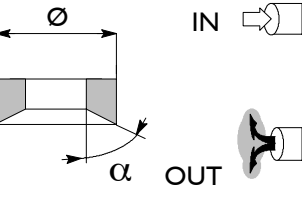
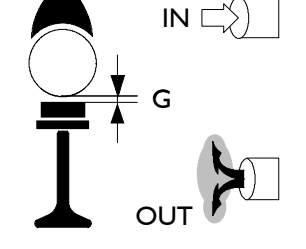
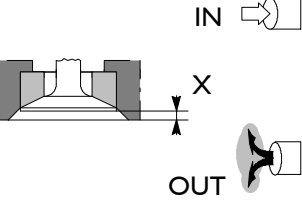

<p>1</p> 	<p>Q.ty</p>	<p>12 aV</p>	<p>6</p> 	<p>X mm</p>	<p>2l</p>
<p>2</p> 	<p>Ø mm</p>	<p>145</p>	<p>7</p> 	<p>X mm</p>	<p>-0,21 ÷ +0,59</p>
<p>3</p> 	<p>X mm</p>	<p>130</p>	<p>8</p> 	<p>X mm</p>	<p>0,173 ÷ 0,217</p>
<p>4</p> 	<p>cm³</p>	<p>25760</p>	<p>9</p> 	<p>X mm</p>	<p>0,030 ÷ 0,095</p>
<p>5</p> <p>Ø</p>		<p>15,9 : 1</p>	<p>10</p> 	<p>Ø mm</p>	<p>145,000 ÷ 145,030</p>

<p>11</p> 	<p>Ø 1 mm</p>	<p>55,015 ÷ 55,030</p>	<p>16</p> 	<p>Ø 1 mm</p>	<p>118,000 ÷ 118,022</p>
<p>12</p> 	<p>Ø 1 mm</p>	<p>54,982 ÷ 54,990</p>	<p>17</p> 	<p>G mm</p>	<p>0,067 ÷ 0,127</p>
<p>13</p> 	<p>G mm</p>	<p>0,025 ÷ 0,048</p>	<p>18</p> 	<p>G mm</p>	<p>0,060 ÷ 0,130</p>
<p>14</p> 	<p>Ø mm</p>	<p>97,950 ÷ 97,972</p>	<p>19</p> 	<p>mm</p>	<p>-0,127 -0,254 -0,508</p>
<p>15</p> 	<p>Ø 1 mm</p>	<p>112,960 ÷ 112,980</p>	<p>20</p> 	<p>G mm</p>	<p>0,070 ÷ 0,270</p>
<p>Ø 2 mm</p>	<p>94,232 ÷ 94,252</p>				

<p>21</p> 	<p>X mm</p>	<p>3,378 ÷ 3,429</p>														
<p>22</p> 	<p>mm</p>	<table border="1"> <tr><td>Ø1</td><td>76,480 ÷ 76,520</td></tr> <tr><td>Ø2</td><td>76,980 ÷ 77,020</td></tr> <tr><td>Ø3</td><td>77,480 ÷ 77,520</td></tr> <tr><td>Ø4</td><td>77,980 ÷ 78,020</td></tr> <tr><td>Ø5</td><td>78,480 ÷ 78,520</td></tr> <tr><td>Ø6</td><td>78,980 ÷ 79,020</td></tr> <tr><td>Ø7</td><td>79,480 ÷ 79,520</td></tr> </table>	Ø1	76,480 ÷ 76,520	Ø2	76,980 ÷ 77,020	Ø3	77,480 ÷ 77,520	Ø4	77,980 ÷ 78,020	Ø5	78,480 ÷ 78,520	Ø6	78,980 ÷ 79,020	Ø7	79,480 ÷ 79,520
Ø1	76,480 ÷ 76,520															
Ø2	76,980 ÷ 77,020															
Ø3	77,480 ÷ 77,520															
Ø4	77,980 ÷ 78,020															
Ø5	78,480 ÷ 78,520															
Ø6	78,980 ÷ 79,020															
Ø7	79,480 ÷ 79,520															
<p>23</p> 	<p>mm</p>	<table border="1"> <tr><td>Ø1</td><td>76,590 ÷ 76,640</td></tr> <tr><td>Ø7</td><td>79,590 ÷ 79,640</td></tr> <tr><td>Ø1</td><td>70,570 ÷ 70,620</td></tr> <tr><td>Ø7</td><td>73,570 ÷ 73,620</td></tr> </table>	Ø1	76,590 ÷ 76,640	Ø7	79,590 ÷ 79,640	Ø1	70,570 ÷ 70,620	Ø7	73,570 ÷ 73,620						
Ø1	76,590 ÷ 76,640															
Ø7	79,590 ÷ 79,640															
Ø1	70,570 ÷ 70,620															
Ø7	73,570 ÷ 73,620															
<p>24</p> 	<p>mm</p>	<table border="1"> <tr><td>Ø1</td><td>70,500 ÷ 70,470</td></tr> <tr><td>Ø2</td><td>71,000 ÷ 70,970</td></tr> <tr><td>Ø3</td><td>71,500 ÷ 71,470</td></tr> <tr><td>Ø4</td><td>72,000 ÷ 71,970</td></tr> <tr><td>Ø5</td><td>72,500 ÷ 72,470</td></tr> <tr><td>Ø6</td><td>73,000 ÷ 72,970</td></tr> <tr><td>Ø7</td><td>73,500 ÷ 73,470</td></tr> </table>	Ø1	70,500 ÷ 70,470	Ø2	71,000 ÷ 70,970	Ø3	71,500 ÷ 71,470	Ø4	72,000 ÷ 71,970	Ø5	72,500 ÷ 72,470	Ø6	73,000 ÷ 72,970	Ø7	73,500 ÷ 73,470
Ø1	70,500 ÷ 70,470															
Ø2	71,000 ÷ 70,970															
Ø3	71,500 ÷ 71,470															
Ø4	72,000 ÷ 71,970															
Ø5	72,500 ÷ 72,470															
Ø6	73,000 ÷ 72,970															
Ø7	73,500 ÷ 73,470															
<p>25</p> 	<p>ORDER</p>	<p>1 - 12 - 5 - 8 - 3 - 10 - 6 - 7 - 2 - 11 - 4 - 9</p>														

<p>26</p> 	<p>I.P.</p>	<p>PE 12P 130A BOSCH</p>
<p>27</p> <p>OIL PRESSURE</p> 	<p>REG.</p>	<p>MECHANICAL</p> <p>MIN: 2</p> <p>bar</p> <p>MAX: 5</p>
<p>28</p> 	<p>TYPE</p>	<p>KKK "K36" (Q.=2)</p>
<p>29</p> 	<p>G mm</p>	<p>0,20 + 0,05</p> <p>G mm</p> <p>0,40 + 0,05</p>
<p>30</p> 	<p>A</p> <p>B</p>	<p>68° ± 2°</p> <p>83°</p> <p>°C</p>

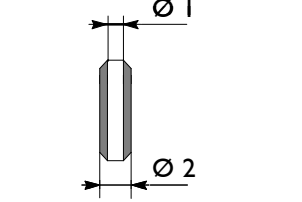
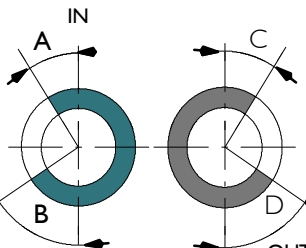
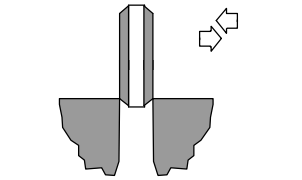
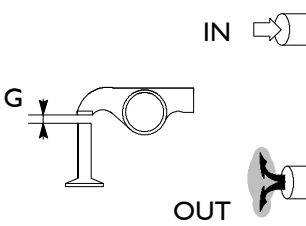
<p>31</p> 	<p>α</p>	<p>60° 15'</p>	<p>36</p> 	<p>H mm</p>	<p>7,550</p>
<p>32</p> 	<p>α</p>	<p>60° 15'</p>	<p>37</p> 	<p>G mm</p>	<p>—</p>
<p>33</p> 	<p>X mm</p>	<p>+0,2 ÷ +0,5</p>	<p>38</p> 	<p>H mm</p>	<p>—</p>
<p>34</p> 	<p>Ø 1 mm</p>	<p>10,025 ÷ 10,040</p>	<p>39</p> 	<p>A</p>	<p>12° 18'</p>
<p>35</p> 	<p>mm</p>	<p>0,010 ÷ 0,039</p>	<p>40</p> 	<p>G mm</p>	<p>0,25</p>
				<p>G mm</p>	<p>0,25</p>

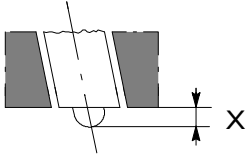
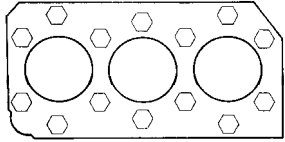
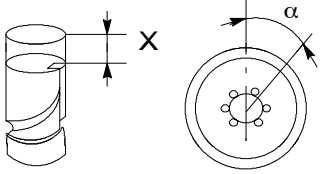
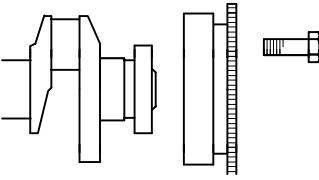
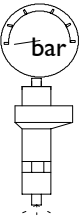
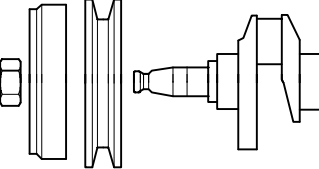
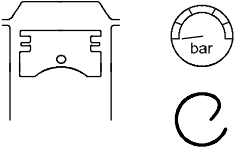
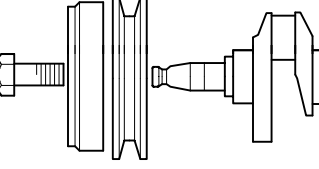
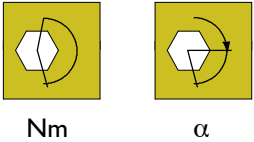
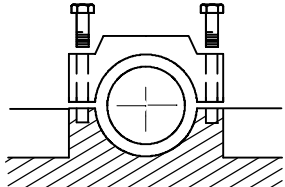
<p>41</p> 	<p>X mm</p>	<p>2,97 ÷ 3,74</p>	<p>46</p> 	<p>Nm</p>	<p>1st STEP 30</p> <p>2nd STEP 160</p> <p>3rd STEP 150°</p>
<p>42</p> 	<p>X mm</p>	<p>5,00 ÷ 5,10</p>	<p>47</p> 	<p>Nm</p>	<p>1st STEP 440</p> <p>2nd STEP 90°</p>
<p>43</p> 	<p>bar</p>	<p>250 + 8</p>	<p>48</p> 	<p>Nm</p>	<p>—</p>
<p>44</p> 	<p>bar</p>	<p>20</p>	<p>49</p> 	<p>Nm</p>	<p>1st STEP —</p> <p>2nd STEP —</p>
<p>45</p> 	<p>Nm</p>	<p>—</p>	<p>50</p> 	<p>Nm</p>	<p>1st STEP 80</p> <p>2nd STEP 120°</p>

ENGINE TYPE

829 | SRM75.12 / 32

829 | SRM85.12

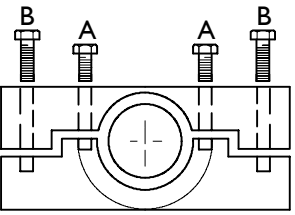

51 	Nm	1 st STEP —
	α	2 nd STEP —

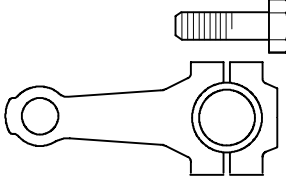
52 	Nm	1 ^s STEP 263 ÷ 290
	α	2 nd STEP —

NOTES: